



INSTALLATION GUIDE

FORMA COMPOSITE CLADDING

Engineered to provide unbeatable durability our composite cladding board boasts an attractive multi-toned surface perfectly mimicking natural timber.

ECOSCAPEUK.CO.UK



+44 (0) 845 9011 988

EcoscapeUK Ltd. Higher Broadfield Farm, Heywood, Greater Manchester, OL10 2TA

CONTENTS

STORAGE & HANDLING	03
SAFETY & USE	04
CLADDING COMPONENTS	05
ACCESSORIES & FIXINGS	06
PRE INSTALLATION NOTES	07 - 08
INSTALLATION	09 - 16

STORAGE & HANDLING

While composite woods are highly durable it is recommended to follow the guidelines when storing, handling and installing the Forma Composite Cladding products to ensure their lasting beauty.

STORAGE

- Materials should be covered until ready to install to ensure a clean surface
- All products shall be stored flat and supported above the ground at 500mm intervals starting at the ends
- Battens used to separate and support the cladding material should be spaced no greater than 500mm
- Supporting battens used in storage should align through the stack to equally transfer the load to the ground
- Where pallets are delivered these should not be stacked more than four pallets high (or 3m high)

HANDLING

- Cladding materials should be placed and not dumped when unloading
- Lift and set boards down rather than sliding the boards to avoid damage
- Carry the cladding boards on their edge for better support
- During installation, do not slide or drag any equipment across the boards
- The surface of the cladding boards shall be kept free of construction debris and material to prevent damage to the boards

SAFETY & USE

Prior to installing any composite cladding system it is recommended that you check with local building codes for any special requirements or restrictions. The diagrams and instructions outlined in this guide are for illustration purposes and are not meant or implied to replace a licensed professional

SAFETY

- Always wear safety glasses and relevant Personal Protection Equipment (PPE)
- When cutting and installing boards it is advised to wear gloves, a respiratory mask, long sleeves and trousers.
- Static build-up is a natural occurring phenomenon that can occur with many composite products. Dry and windy environments may make this more apparent. The levels of static build up will not cause personal injury.
- Forma composite boards CANNOT be directly installed onto a flat surface. It must be installed onto a substructure to allow adequate and unobstructed air flow under the cladding to prevent excessive water absorption. A minimum of 25mm clearance beneath the cladding should be provide to promote drainage and drying.
- Excessive heat on the surface of the composite cladding products from external sources such as (but not limited to) fire or reflection of sunlight from energy efficient window products such as Low-E glass can cause an unusual heat build-up on exterior surfaces. The rise in surface temperature from Low-E glass to adverse levels is deemed extremely rare in the UK due to the prevailing climate. Excessive heat exposure can cause the boards to sag, warp, discolour, increase expansion/ contraction, accelerate weathering and in extreme circumstances melting of the board.

USE

- Standard woodworking tools may be used. It is recommended that all blades have a carbide tip. Stainless steel or acceptable coated screws are recommended.
- Plan a layout for your cladding before starting to ensure the best looking layout is achieved. Pay particular attention to interfaces with doors, windows and soffits in order to determine the optimal starting position for the first boards.
- Forma Composite Cladding Boards are not intended for use as columns, support post, beams, joist stringers or other primary load-bearing members.
- Boards must be supported by a compliant substructure and CANNOT be installed onto existing cladding boards.
- All fixings should be fastened at a 90degree angle to the cladding system.
- Use white chalk, straight boards or string lines as templates. NEVER use coloured chalk on the boards as this can cause permanent staining.
- All recommended fixings are available from EcoscapeUK Ltd. Please consult with the technical department for further advice.

CLADDING COMPONENTS

Please ensure you are familiar with all the cladding components prior to starting.

FORMA Cladding Board (13x142x2400/3600)
ECO2400 & ECO3600

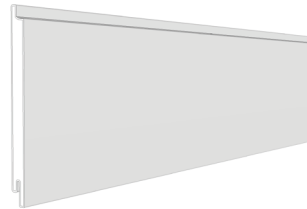

FORMA Cladding 'Internal' Corner Trim (72x72x3600)
ECO7272

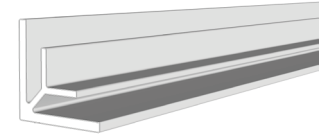

FORMA Cladding 'F Shape' End Trim (47x46x3600)
ECO4746



FORMA Cladding 'Finishing Board' (80x15x3600)
ECO8015



FORMA Cladding 'Joint' Trim (79x24x3600)
ECO7923

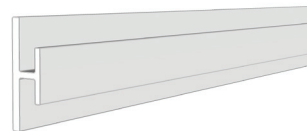

FORMA Cladding 'Angle Trim' (40x40x3600)
ECO4040

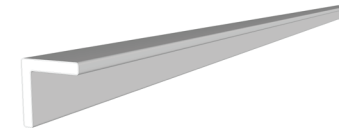

FORMA Cladding 'External' Corner Trim (58x58x3600)
ECO5858



ACCESSORIES & FIXINGS

Please ensure you are familiar with all the accessories & fixings prior to starting.

Aluminium Cladding Clips (250pcs)
ECO701CC

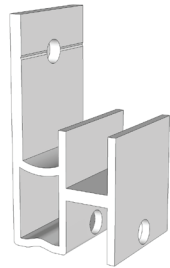

Wood Screws for Cladding Clips (500pcs)
ECO704CW

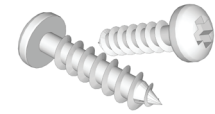

Aluminium Cladding Starter Bar (3000mm)
ECO702SB

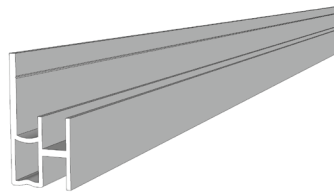

Aluminium Screw for Starter Bar (500pcs)
ECO705CA

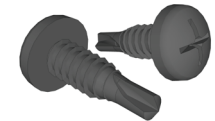

Plastic Pad (18x8mm)
ECO703PP



PRE INSTALLATION NOTES

Due to the natural expansion and contraction of the composite material with changes in ambient temperature and humidity please ensure the following 'gap' requirements for all Forma Composite Cladding products are achieved.

SPACING BOARDS & JOISTS

- Cladding board ends should be installed with an adequate expansion gap between adjoining boards (see Expansion Gap Table on p18).
- Timber joists shall be installed with a 20mm gap between ends.
- A 15mm gap shall be provided between the lowest cladding board edge and the ground.
- A clear cavity between the rear face of the cladding and the outer wall/ surface of the structure being clad should be provided of no less than 25mm to allow sufficient airflow.
- Joists shall be no more than 500mm from centre to centre.
- Extra care is required in order to provide sufficient joisting around windows, fascia's, soffits, guttering, ventilation points and corners of walls. These locations should be planned and co-ordinated with the Forma Cladding system to ensure alignment with the composite fascias and trims. This will allow fixing of the fascia & trims back to the joists.
- A double joist arrangement will be required for mid panel joints and at corners to allow the Joint Trims to be seated and fixed to both joists.

Below is an example of a typical installation and will be used to demonstrate the installation of the Forma Composite Cladding System:

TYPICAL INSTALLATION: GARDEN ROOM

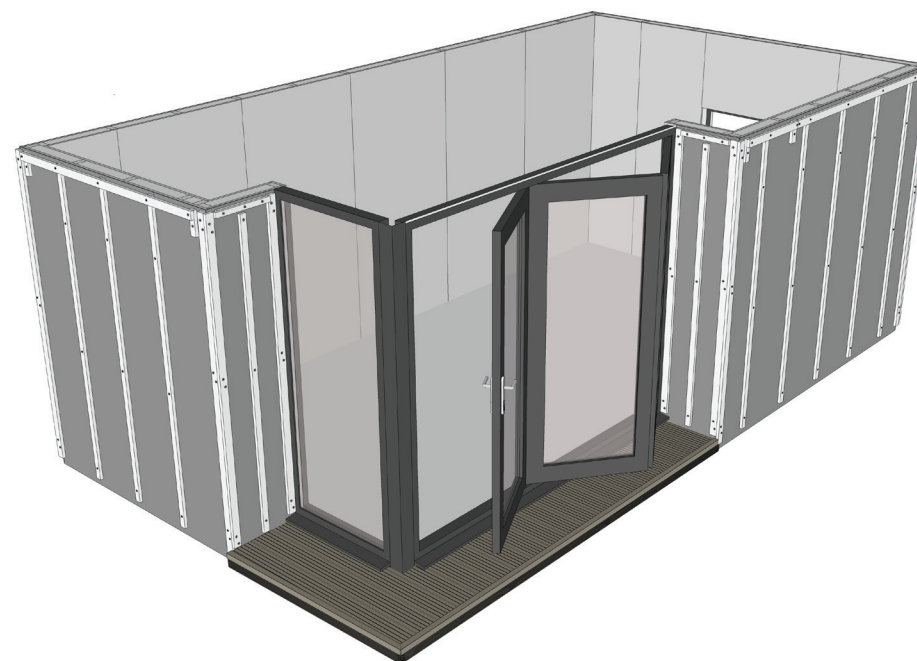

PRE INSTALLATION NOTES

CLADDING JOIST LAYOUT:

Joists that are fixed directly to the outer wall once a waterproof membrane /vapour barrier is in place. This is the most common method for boards installed horizontally.

If the wall is uneven or cannot bear additional loads, the cladding may be fixed to battens on a self-supporting frame.

JOIST SPECIFICATION:

- Cladding can be fixed to pressure treated softwood timber joists (in accordance with BS8417) or Aluminium battens depending on design requirements.
- Joists should be fixed into position at 500mm centres using suitable A4 stainless steel countersunk wood/ masonry screws. All joists need to be fixed in a minimum of 3 places.
- All joists need to be minimum 25mm thick, flat and leveled against the wall. Use shims as required.
- Joists to be used at external corners should be at least 50mm wide to accommodate the External Angle Trim and provide space for the Aluminium Cladding Clips to be fixed.
- External Corner Joists: 25mm thick x 50mm wide
- Standard Joists: 25mm thick x 38mm wide
- Finishing Board Batten: 19mm thick x 32mm wide

*** A building professional should be consulted regarding vapour barriers and insulation for your project. Where a vapour barrier is to be used, it should be a breathable type and must be positioned behind the joists to allow the cladding a minimum 25mm airflow. It is essential that a barrier/ coating is installed to prevent water penetration.

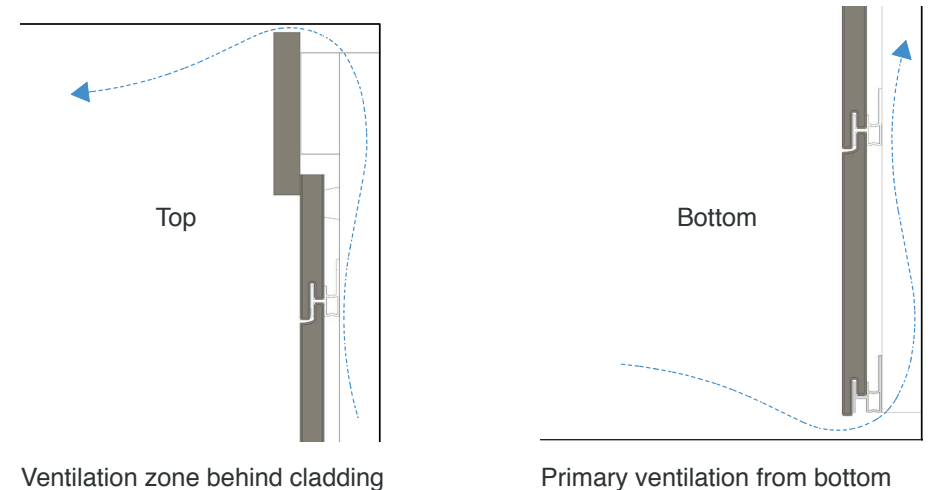
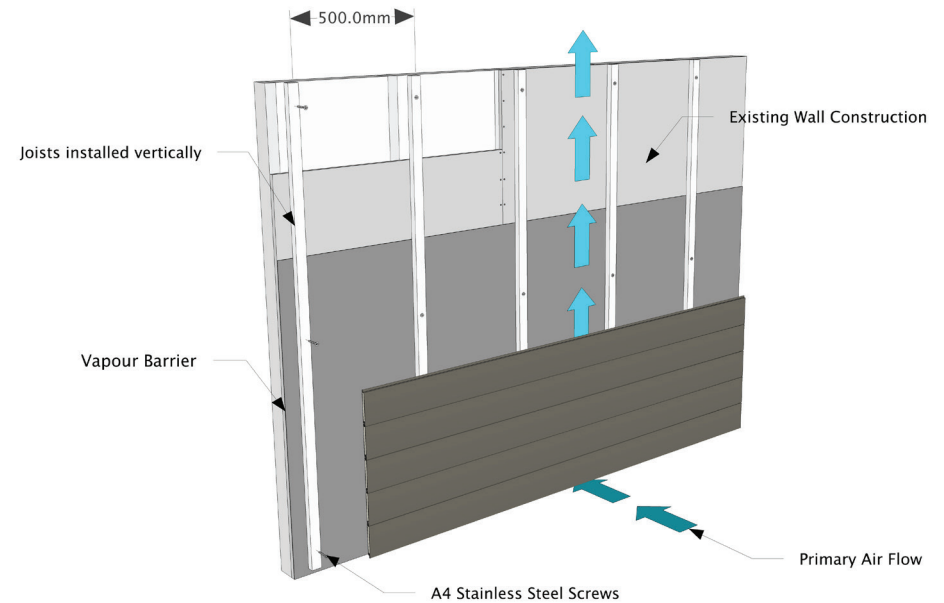

INSTALLATION

STEP 1 - SETTING OUT THE JOISTS

Working from a corner (internal or external) mark out the joists every 500mm max. Additional joists will be required around edges such as windows, doors, eaves and corners where additional joists should be installed specifically to carry the final cladding trims.

Intermediate Joint Trims need to be planned as they will require two joists spaced either side to allow fixing of the Aluminium Clips whilst providing a solid base for the Joint Trim to be fixed back to.

It is advisable to fix the final location of the Intermediate Joint Trim Joists during installation of the Cladding Boards to enable precise positioning.

We now need to decide the start height for the joists. In order to do this we need to determine how the final cladding boards will align with adjacent doors and windows.

The aim is to avoid creating thin slithers of cladding (which will be difficult to cut on site) so by planning where the boards will finish we are able to adjust the start height off the ground.

Joists and cladding should be no closer than 15mm from the ground.

* Minimum 25x50mm wide joists will be required for all external corners including windows and doors. All other joists can be a standard 25x38mm.

** For the Finishing Board beneath the eaves we recommend using 19mm x 32mm treated battens fixed to the face of the main cladding joists. This will allow the Finishing Board to hold the top cladding board tightly in place.

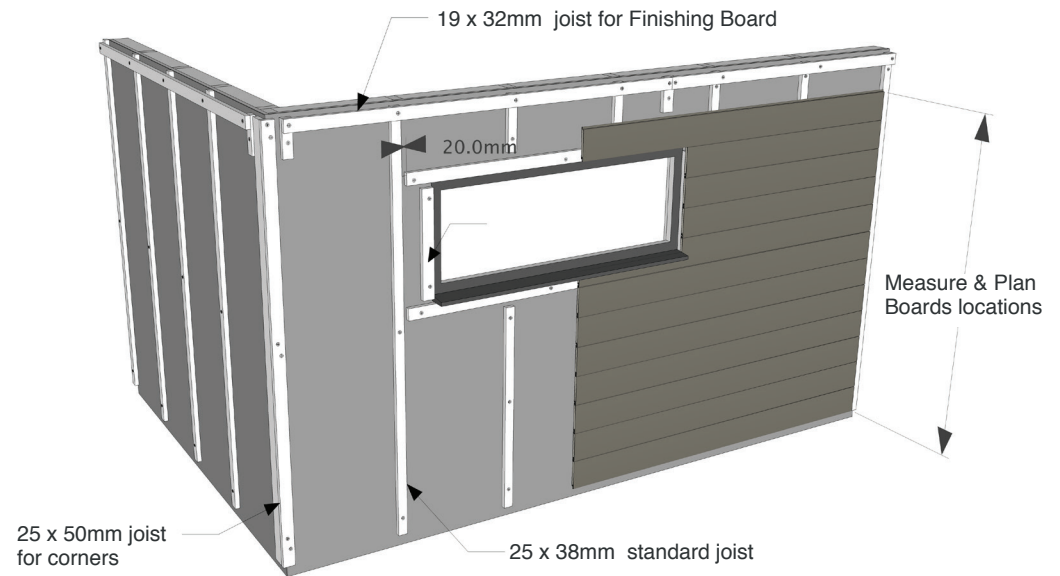

INSTALLATION

STEP 2 - BEFORE INSTALLING THE CLADDING

Before the cladding can be installed we must first fix in place two vertical trims in order that the cladding boards can be slotted into place during installation.

Working from a corner the cladding will be installed in a single direction around the building, in 'portions'. Each portion is defined with two vertical trims that the Cladding Boards can be slotted into, leaving no board end exposed.

- a) Fix the first vertical trim to the joist using countersunk wood screws every 750mm ensuring that the screws are installed through the rear flange. It is advised to pre-drill pilot holes.
- b) We now need to position the second Trim (and associated Joists if installing a Joint Trim) to allow the Cladding Boards to be slotted into. The spacing of the Trim will depend on the length of Board being installed.

The aim is to ensure that 6mm of the Cladding Board is housed within the Trim at both ends.

It is recommended that the distance between the outer faces of both Trims is equal to the length of the Cladding Board minus (-) 12mm.

***** The Cladding Board will therefore be 12mm longer than the gap between the Trims. See diagram opposite*****

This will allow the Cladding Board to be fully pushed into the 1st Trim and then drawn back 6mm to fit within the 2nd Trim, achieving 6mm cover to both ends.

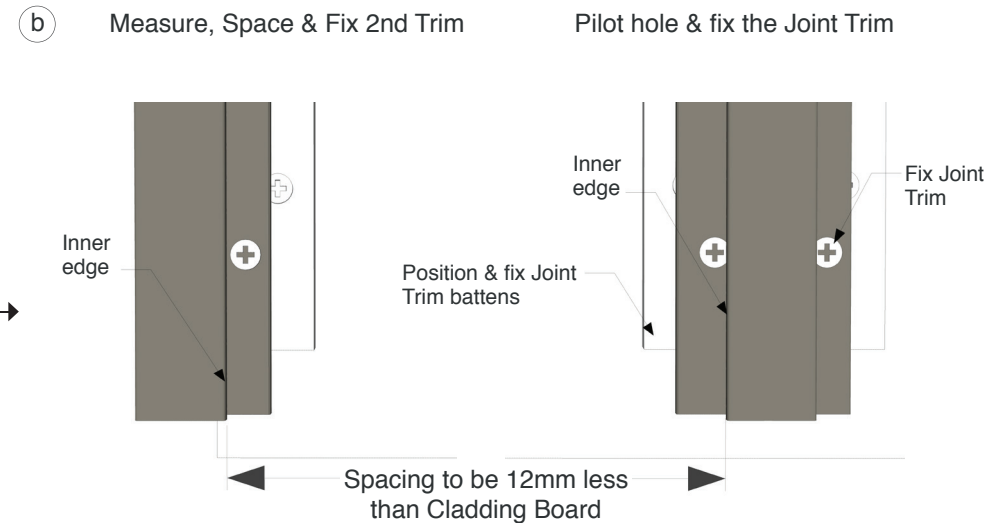
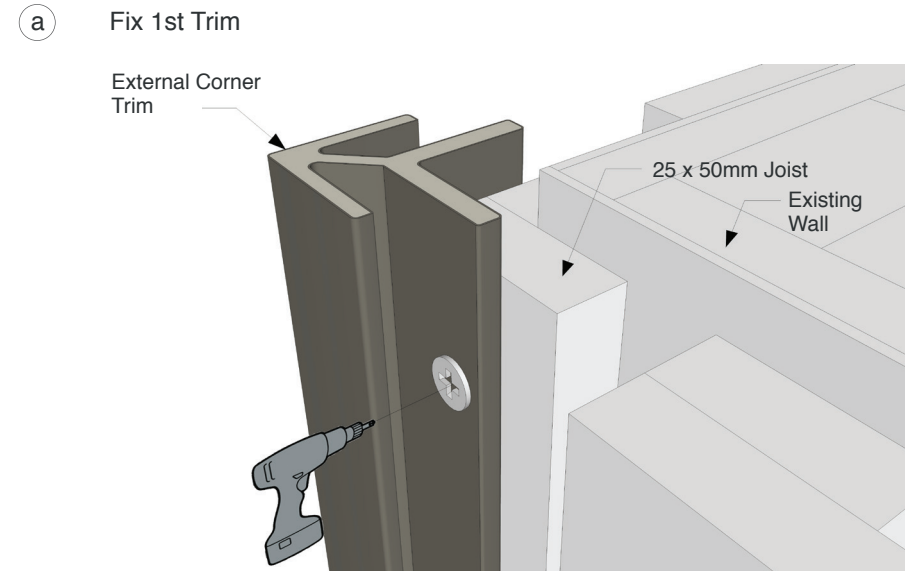

INSTALLATION

STEP 3 - INSTALL THE STARTER BAR

- c The Starter Bar (ECO702SB) will now be installed on top of the bottom of the joists by first pre-drilling into the Aluminium Starter Bar and then fixing to each joist using the screws (ECO705CA).
- d Ensure the Starter Bar is installed in the correct orientation and level. Please note that all Cladding Boards and Trims should be no closer than 15mm to the ground.

c Pre-drill & fix Starter Bar

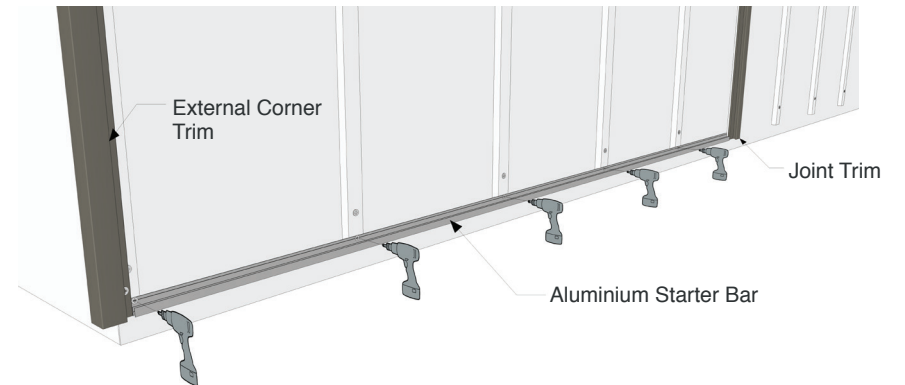

d Starter Bar correct orientation

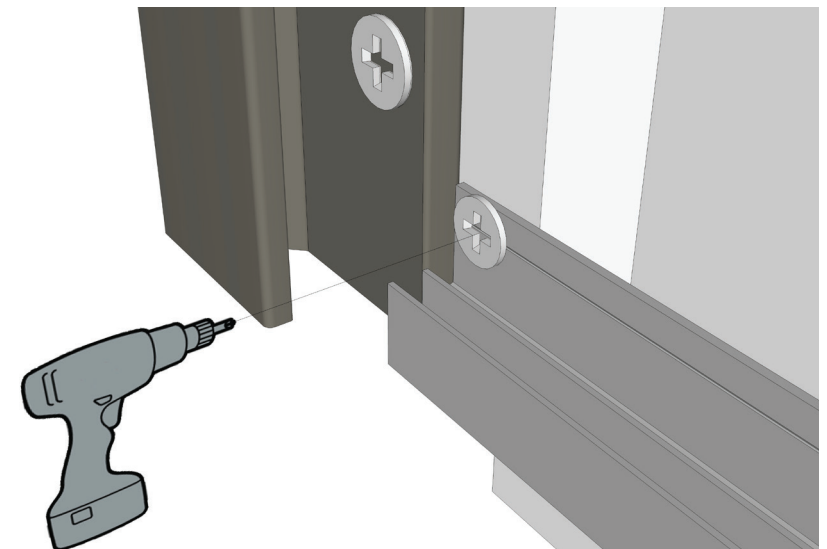

INSTALLATION

STEP 4 - INSTALL THE FIRST CLADDING BOARD

- e Take a Cladding Board and place the side with the lip down onto the Starter Bar. You will find the 2nd Trim prevents the Board from sitting fully on the Starter Bar.

Slide the cladding board fully into the recess of the 1st composite trim, bringing the opposite end of the Cladding Board down onto the Starter Bar. The Cladding Board should now be fully seated.

- f We now need to draw the Cladding Board back out of the 1st trim by 6mm and into the 2nd trim to allow the Board to be fully housed at both ends.

Next, take the Aluminium Cladding Clips (ECO710CC) and put them on top of the board, fixing them directly to each joist using wood screws (ECO704CW).

*** Do not fix the Clips to the cladding board itself, just the joist.

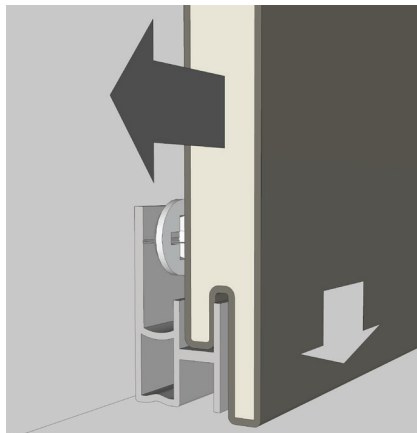

Slide Board fully into 1st Trim

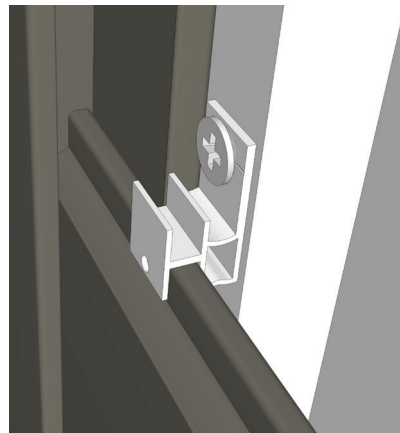

Fix Aluminium Clips to each Joist

- e First Cladding Board being positioned onto Starter Bar & into 1st Trim

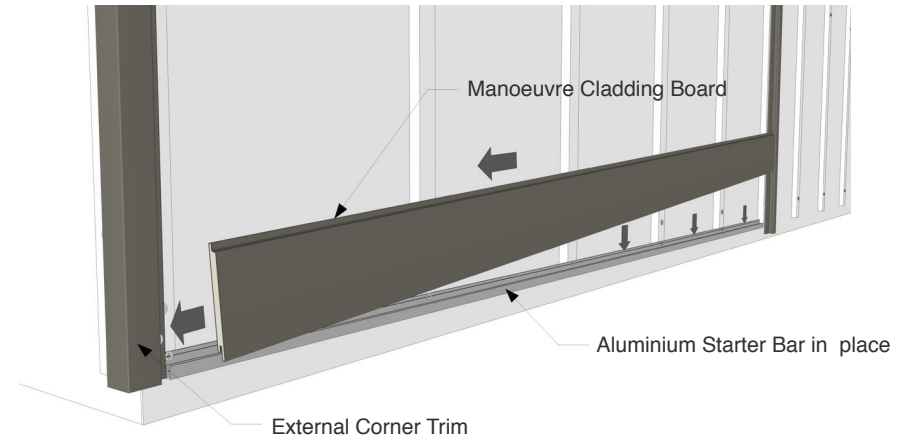

- f Draw back Cladding Board by 6mm and push into 2nd Trim

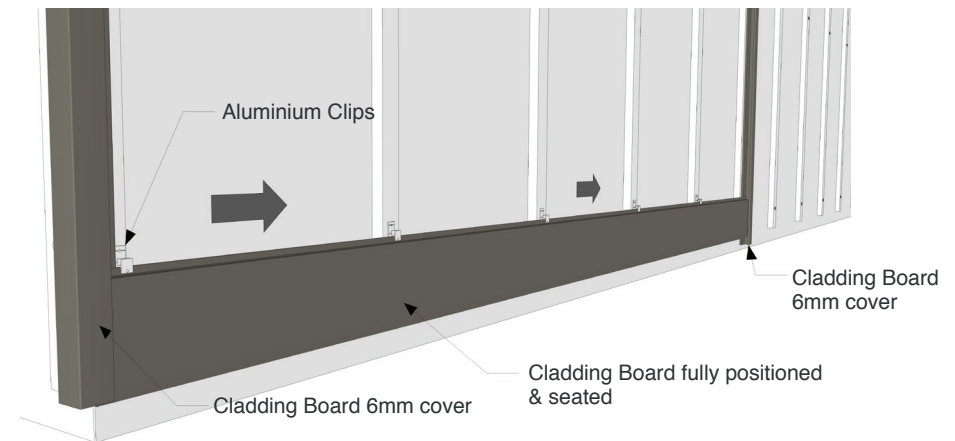

INSTALLATION

STEP 5 - LOCKING THE WALL CLADDING BOARD

- g Now we need to lock the board and control expansion and contraction. We will do this by using the extra hole provided on the Cladding Clips (ECO710CC). We will be locking the board down half way along its length to allow for even movement to take place either end of the board.

Using the wood screws (ECO704CW) fix the Aluminium Cladding Clip to the Cladding Board. It is advised to pre-drill pilot holes.

Only one locking point is required for each Cladding Board and centrally located (approx) as shown in red below. Each board must be locked in place.

STEP 6 - INSTALL THE REMAINING CLADDING BOARDS (VERTICALLY)

- h Repeat steps 4 & 5 and install all the cladding boards until you have reached the top of your wall. Refer to Step 7 for the final board beneath the eaves.

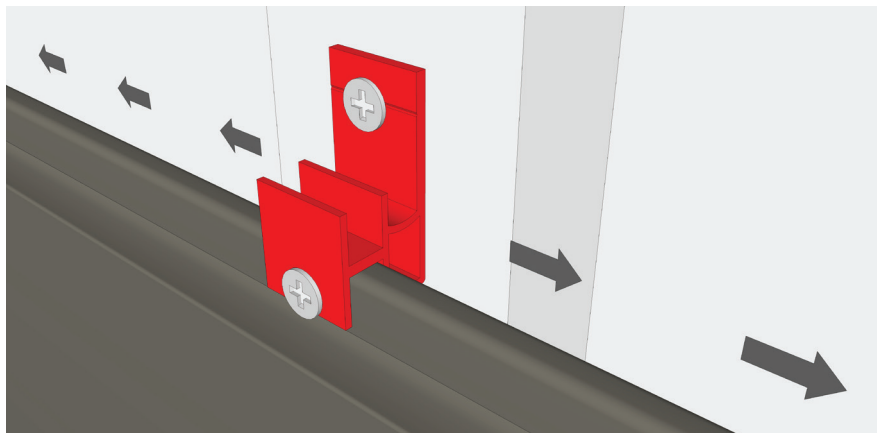

Lock centre of each board using screws (ECO704CW)

- g Controlling Expansion & Contraction: Lock the board in one location

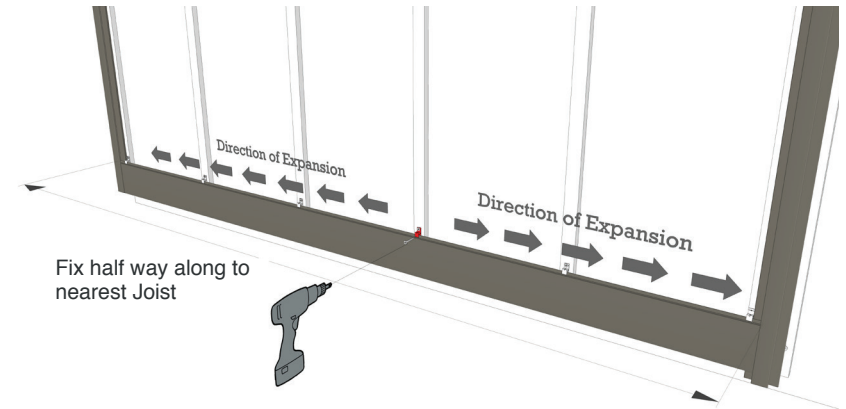

- h Installing remaining boards up to the last 'full' board

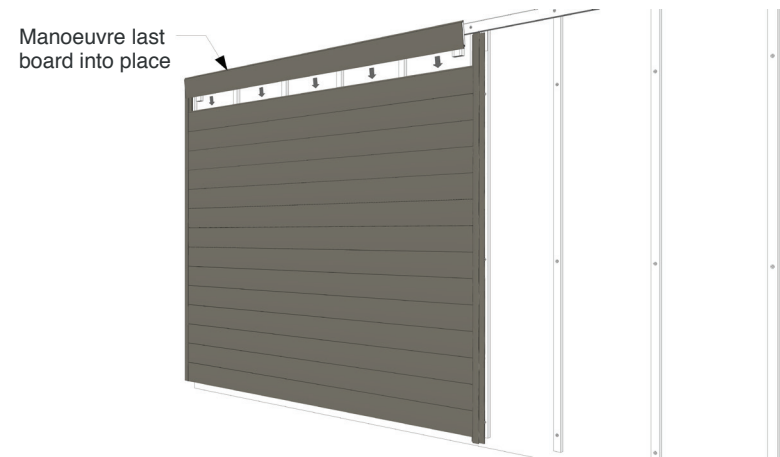

INSTALLATION

STEP 7 - INSTALLING THE TOP CLADDING BOARD

- i The Aluminium Cladding Clips will not be used for the top board, instead fix the Plastic Pads (ECO703PP) to the joists so that they sit approx 25mm below the horizontal joist. These pads will prevent the board rattling once the installation is completed so must be installed.

- j Measure and cut the Cladding board as required to fit beneath the top horizontal joist. Please allow a max **10mm gap** between cladding board and horizontal joist.

The top Cladding Board should now be installed. Slide the board into the 1st Trim, draw back by 6mm whilst pushing the opposite end into the 2nd Trim.

- i Fix the Plastic pads 25mm below top joist

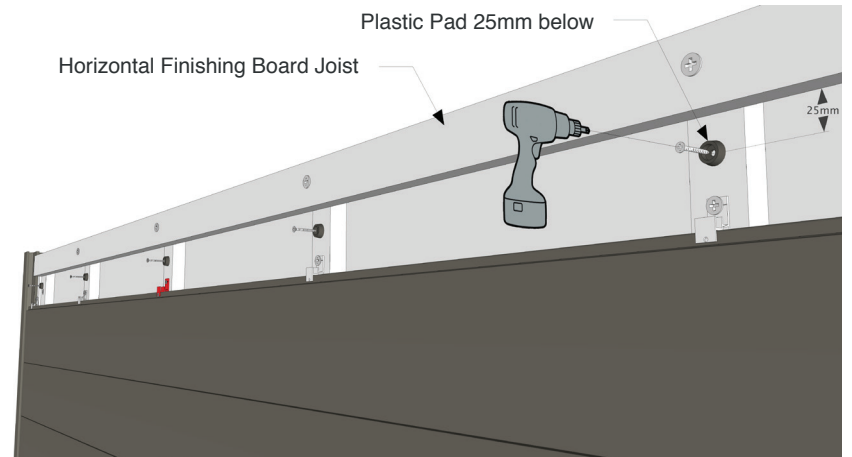

- j Cut final board max 10mm below top joist

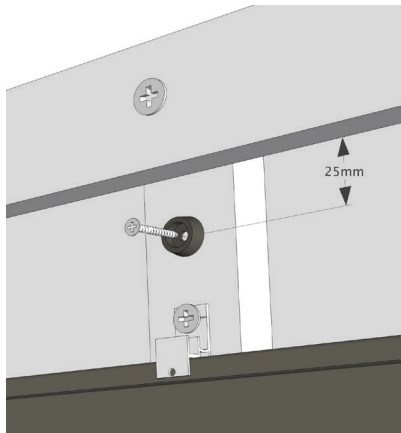
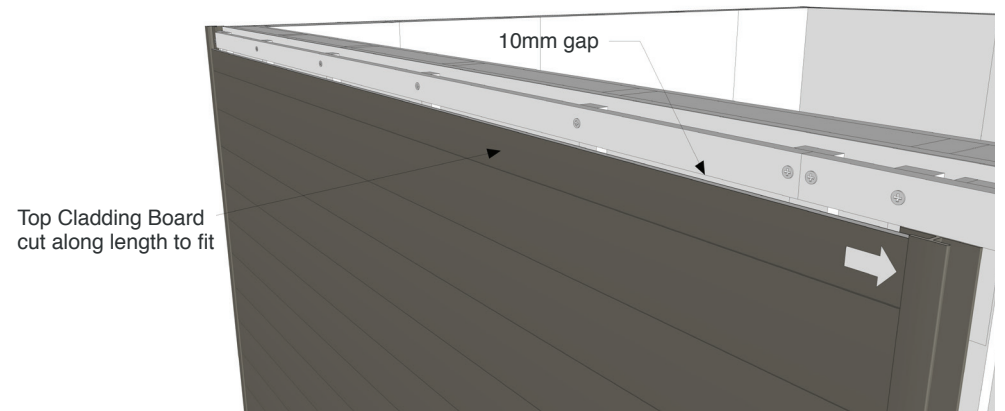

Plastic Pads fixed to joist

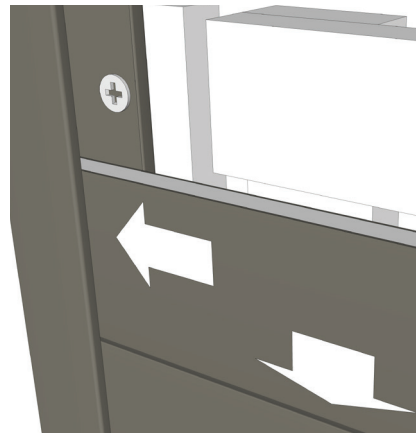

Board slotted into trim & drawn back

INSTALLATION

STEP 8 - INSTALLING THE FINISHING BOARD

- (k) A final Finishing Board (ECO8015) will be used to cover the top of the final cladding board.

The Finishing Board will be screwed back to the timber joist running horizontally beneath the eaves as installed in Step (1). Colour coded screws should be used for this purpose (Available from Ecoscape UK)

- (l) It is recommended that the ends of the Finishing Boards align with the centreline of the vertical trims, although not essential.

Please allow a 3mm* gap between bottom of Finishing Board and top of Vertical Trim for expansion.

The Finishing Board can be installed after each portion of cladding is completed or at the very end of the installation.

*exact gap required changes with ambient temperature and board length (see Expansion Gap Table on p18)

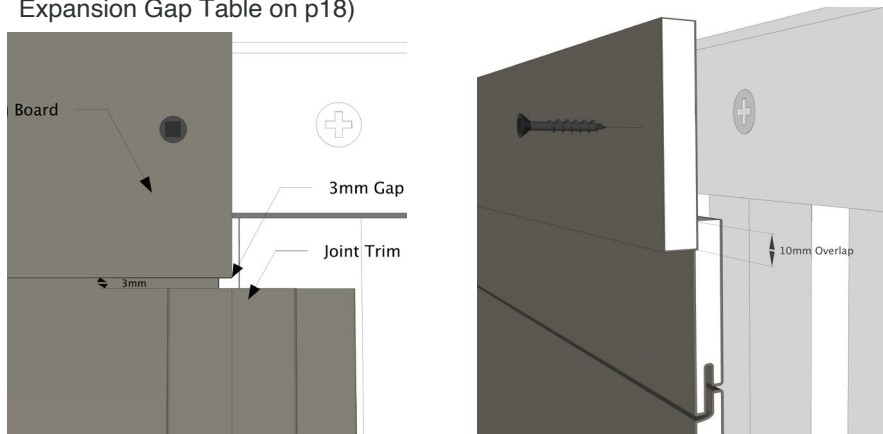

3mm* gap between Board & Trim

10mm overlap to Cladding Board

- (k) Fix the Finishing Board to the top horizontal joist

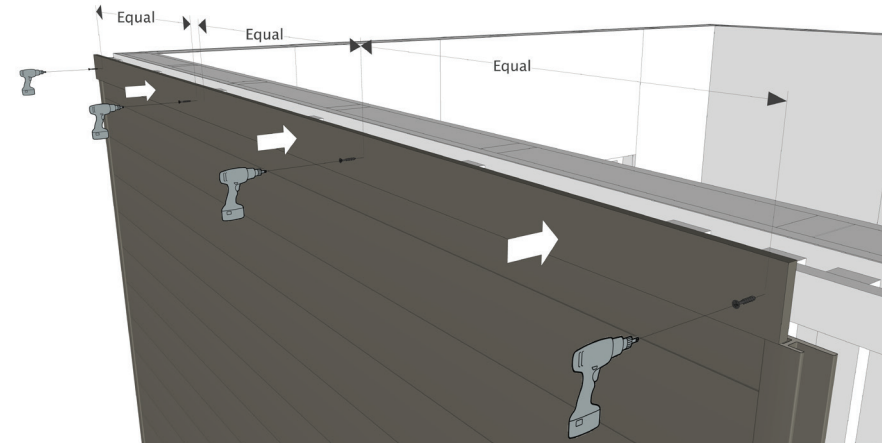

- (l) Align the ends of the Finishing Board with the future Joint Trim

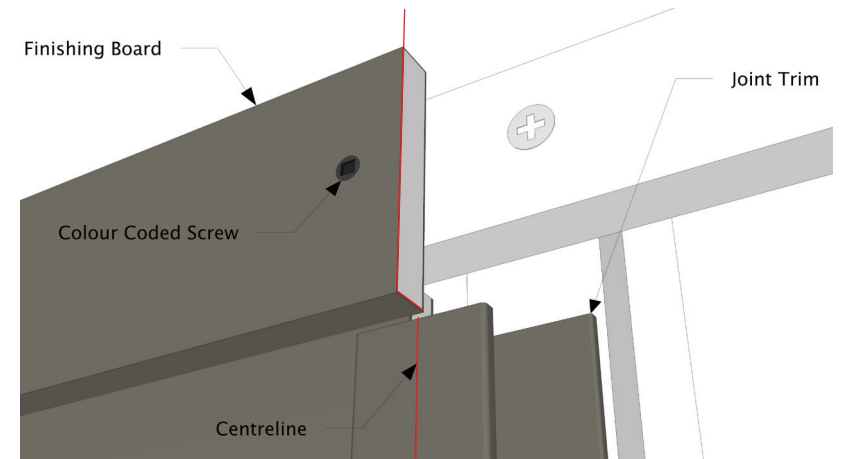

INSTALLATION

STEP 9 - TRIMS AROUND DOORS & WINDOWS

Where Doors, Windows or other features need accommodating in the cladding system please ensure that trims around the openings are installed before the Cladding Boards.

Full access is required to enable it to be fixed back to the joists in the same way as Step (2).

Additional joists will be required around windows & doors to fully support the corner trims and cladding.

- m For this example we will use the 'F Shape' End Trim (ECO4746) to form the edges and reveals to a window.

Cut the End Trims to the desired length and fix back to the timber joists using wood screws (ECO704CW).

- n We advise forming mitre joints to all corners for a clean and neat finish.

Once the edges around the Window have been fixed continue to install the Cladding Boards as Steps (2 - 8)

Job Done! Please consult with the technical department for further advice.

- m Measure, Cut & Fix End Trim to joists

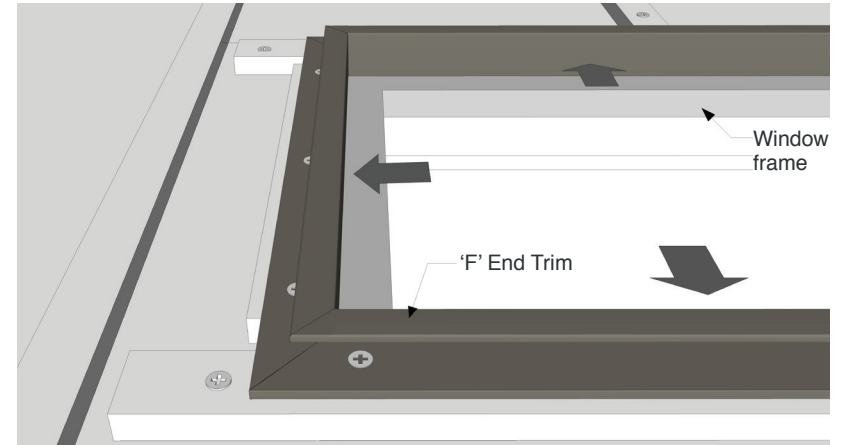

- n Mitre corners work best to achieve neatest finish

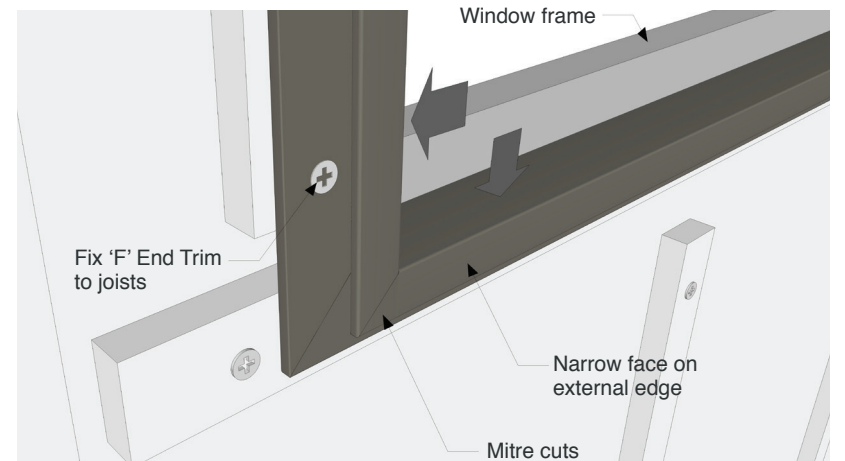

INSTALLATION

Job Done! Please consult with the technical department for further advice.

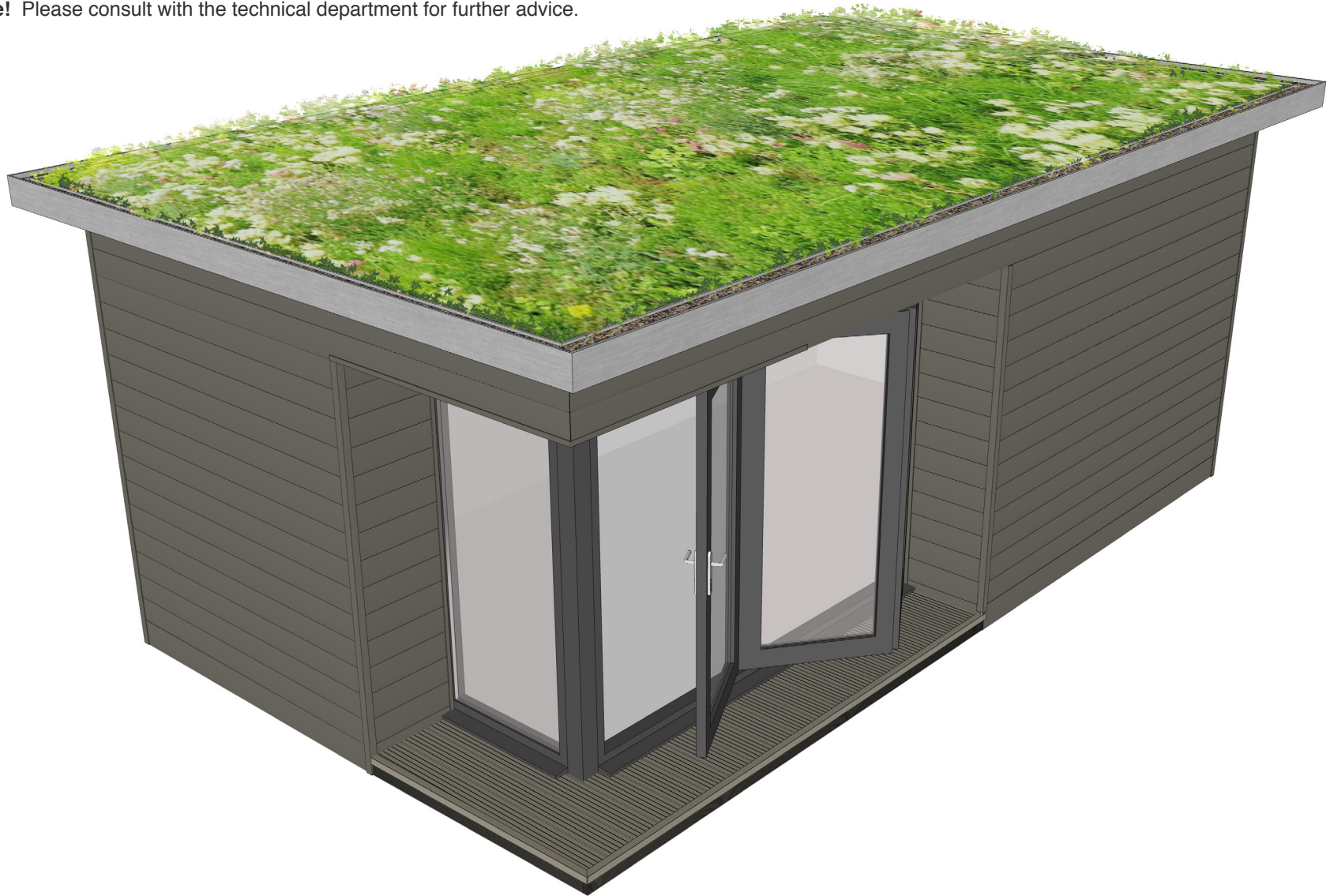

EXPANSION GAP TABLE

Please refer to the table below when installing the cladding boards to determine the gap (mm) between boards and adjacent structures.

Please note this table covers expansion and contraction values for UK, Europe

		Length (Meters)									
		1	2.44	2.8	3	3.66	3.9	4	4.88	5.4	
Installation Temperature (°C)	-10	2.4	5.9	6.7	7.2	8.8	9.4	9.6	11.7	13.0	Gap (mm)
	-5	2.2	5.4	6.2	6.6	8.1	8.6	8.8	10.7	11.9	
	0	2.0	4.9	5.6	6.0	7.3	7.8	8.0	9.8	10.8	
	5	1.8	4.4	5.0	5.4	6.6	7.0	7.2	8.8	9.7	
	10	1.6	3.9	4.5	4.8	5.9	6.2	6.4	7.8	8.6	
	15	1.4	3.4	3.9	4.2	5.1	5.5	5.6	6.8	7.6	
	20	1.2	2.9	3.4	3.6	4.4	4.7	4.8	5.9	6.5	
	25	1.0	2.4	2.8	3.0	3.7	3.9	4.0	4.9	5.4	
	30	0.8	2.0	2.2	2.4	2.9	3.1	3.2	3.9	4.3	
	35	0.6	1.5	1.7	1.8	2.2	2.3	2.4	2.9	3.2	
	40	0.4	1.0	1.1	1.2	1.5	1.6	1.6	2.0	2.2	

FORMA[®]

COMPOSITE CLADDING

ECOSCAPEUK.CO.UK



+44 (0) 845 9011 988

EcoscapeUK Ltd. Higher Broadfield Farm, Heywood, Greater Manchester, OL10 2TA